

RevNo	Revision note	Rev-By	RevDate	Signature	Checked

"DHP"
NEW TYPE

FIXED AND SLIDING DRAWER - FIBER PATCH PANEL



ITEM NO: FBPP-DHP-RM (Box only)



Rear View

KEY FEATURES:

- 1.5 U Height, 19" Patch Panel
- Sliding Drawer
- Unloaded adapter
- Without Front Adapter Frame
- Simple Snap in slide drawer and fixed
- Color : Beige or Black standard
- Material : Aluminium
- Size : 482 x 66 x 223mm

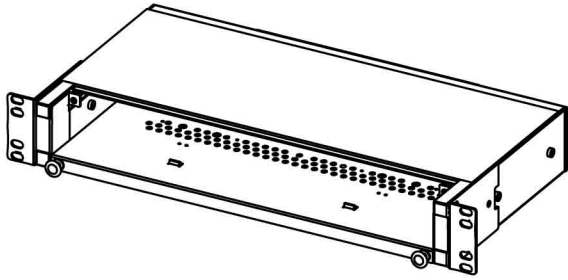

Front Angle View

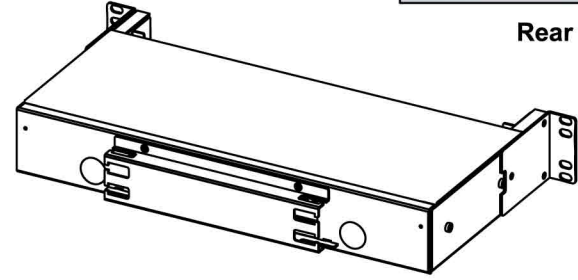

Rear Angle View

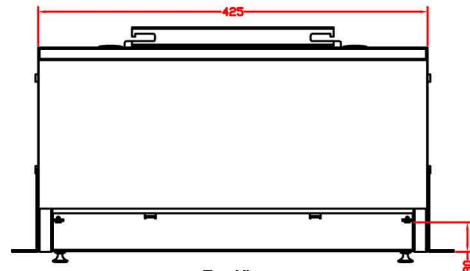

Top View



Front View

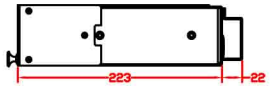
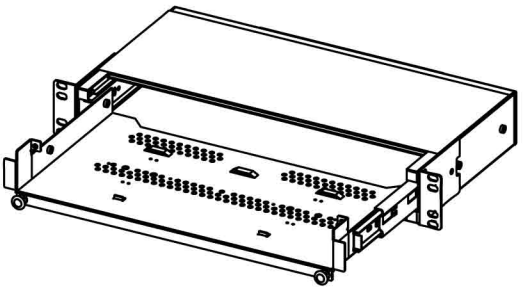

Side View

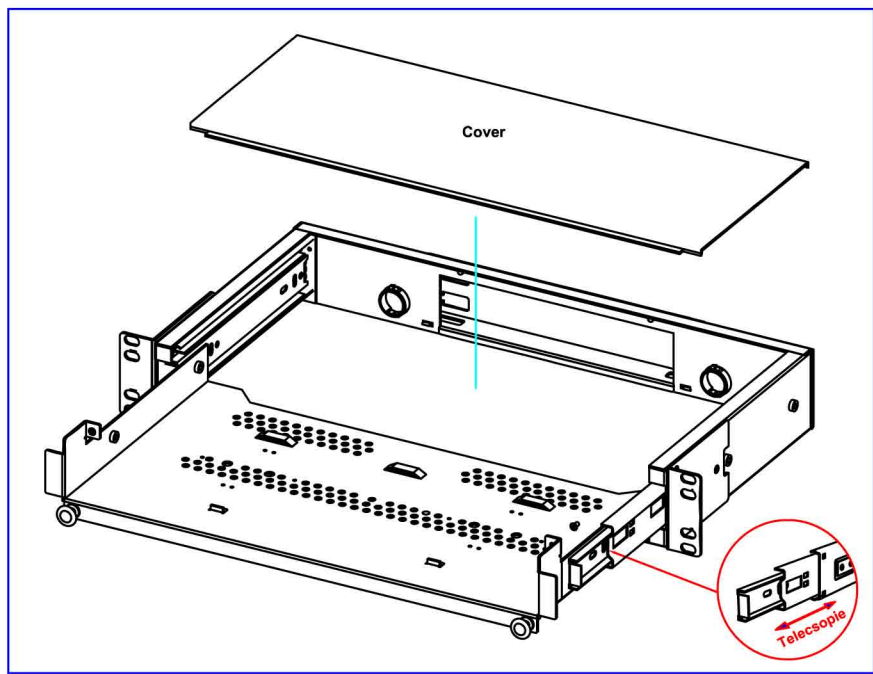

Structure View

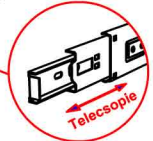

Without Front Adapter Frame

Note: Front Adapter Frame is optional

- Adapter Frame : ST : 24 ports ST Simplex
- SC : 24 ports SC Simplex, 12 Ports SC Duplex , 24 Ports Duplex
- LC : 12 ports LC Dulpex, 24 Ports LC Duplex

ITEM NO.	FBPP-DHP-RM (Box only)			
CUSTOMER NO.	DATE	130315	UNIT	MM
DESIGNED BY	ALEX	SCALE	0.25:1	VER.
NO.	Checked by			
APPR:	Approved by -date			

