

Accessories for FTTO Installation Components

A multitude of installation options – simply illustrated

Version 3.1



What This Guide Sets Out to Achieve

As a specialist for fiber optic-based transmission systems, MICROSENS offers the broadest portfolio of network components designed for professional integration in device installation ducts, underfloor systems, walls and desks currently available on the market.

We offer an extensive portfolio of installation accessories for installing our components. This document contains recommendations on how to expand an existing installation as well as how to realise a brand-new setup.

The goal is to identify the perfect accessories for the given installation environment (e.g. cable duct and socket from manufacturer xy). This is aimed at achieving an optimal result with respect to mechanical stability, an installation which conforms to all the current standards and an attractive design.

MICROSENS 2018 - installation systems with no compromises!

CONTENTS

- 1. Introduction to Fiber To The Office (FTTO)..... 5**
- 2. Introduction to M45 Modular Technology 6**
- 3. Greater Security for Your Micro Switch 9**
- 4. Device Installation Ducts and Conduits 10**
 - 4.1 Installation Set with Universal Device Brackets for Ducts with an Anchor Rail ..11
 - 4.2 Installation Set for Front-Locking Tehalit Ducts12
 - 4.3 Device Installation Ducts with Standard E2 Sockets.....13
 - 4.4 Flush Right Installation in an E2 Socket.....14
 - 4.5 Installation Set for Front-Locking Kleinhuis Ducts.....15
 - 4.6 Installation Set for Front-Locking Niedax Ducts16
 - 4.7 Tehalit Device Installation Ducts17
 - 4.8 Device Installation Ducts Manufactured by OBO BETTERMANN20
 - 4.9 Socket Overview - Sorted by Duct Manufacturer22
 - 4.10 PoE Power Supply Installation in a Device Installation Duct.....28
 - 4.10.1 Installation on a C-profile, 35 mm combi-rail or 35 mm DIN rail.....28
 - 4.10.2 Installation in a Front-Locking Tehalit Duct.....29
 - 4.10.3 Magnetic Installation.....29
- 5 Underfloor Installation 32**
 - 5.1 Installation Sets for OBO Underfloor Systems33
 - 5.2 OBO Underfloor Tanks (formerly Ackermann)34
 - 5.3 electraplan Supply Units.....36
 - 5.4 PUK Underfloor Systems37
 - 5.5 Installation Set for PUK Underfloor Systems with Increased PoE Requirements 39
 - 5.6 Underfloor PoE Power Supply Installation40
- 6 Modular Chassis for Universal Applications 42**
 - 6.1 GT Chassis42
 - 6.2 Slim Chassis45
 - 6.3 Accessories.....47
 - 6.3.1 Installation Options for GT and SLIM Chassis47
 - 6.3.2 M45 Dummy Modules47
 - 6.3.3 M45 Plug Sockets47
 - 6.3.4 More M45 Installation Components48
 - 6.4 Rapid 45 Installation Set for Surface Mounting49
- 7 Wall Installation..... 50**
 - 7.1 Installation Set for Hollow Wall Installation.....51
 - 7.2 Installation Set for Concealed Wall Installation.....52

- 7.3 Installation Set for KAISER Sockets53
- 7.4 PoE+ Power Supply Installation in a Wall Configuration.....55
- 8 Furniture Installation 56**
- 8.1 Furniture Inlet Casing57
- 8.2 Retractable Modular Aluminium Pillar58
- 9 Industrial Installations..... 60**
- 9.1 DIN Rail Installation60
- 9.2 IP67 Mast Box62
- 9.3 19" Profile with 35 mm DIN Rail.....64
- 9.4 Additional Accessories for the Industrial Sector65
 - 9.4.1 Device Wiring65
 - 9.4.2 Cable Feed, resp. Cable Fixing Plate65
 - 9.4.3 Locking Block for DIN Rails.....65

1. Introduction to Fiber To The Office (FTTO)

Fiber To The Office (FTTO) is a EN50173-compliant and decentralised networking concept for modern office environments that intelligently combines the benefits of fiber optic and copper based cabling technologies.

In contrast to a classic Structured Cabling Network (SCN), FTTO deploys fiber optic cables throughout – all the way from the central wiring closet to the workplace area. Copper cabling is solely used for the last few metres to connect IP terminal equipment directly up to the MICROSENS Micro Switches.

The intelligent equalisation of the power density and the low space requirements compared to copper cabling have a noticeable, positive impact on economic results. FTTO completely cuts out the need for classical technical rooms on each floor which produce high costs due to their space and cooling requirements. For more information on our FTTO concept, please refer to www.microsens.de/ftto

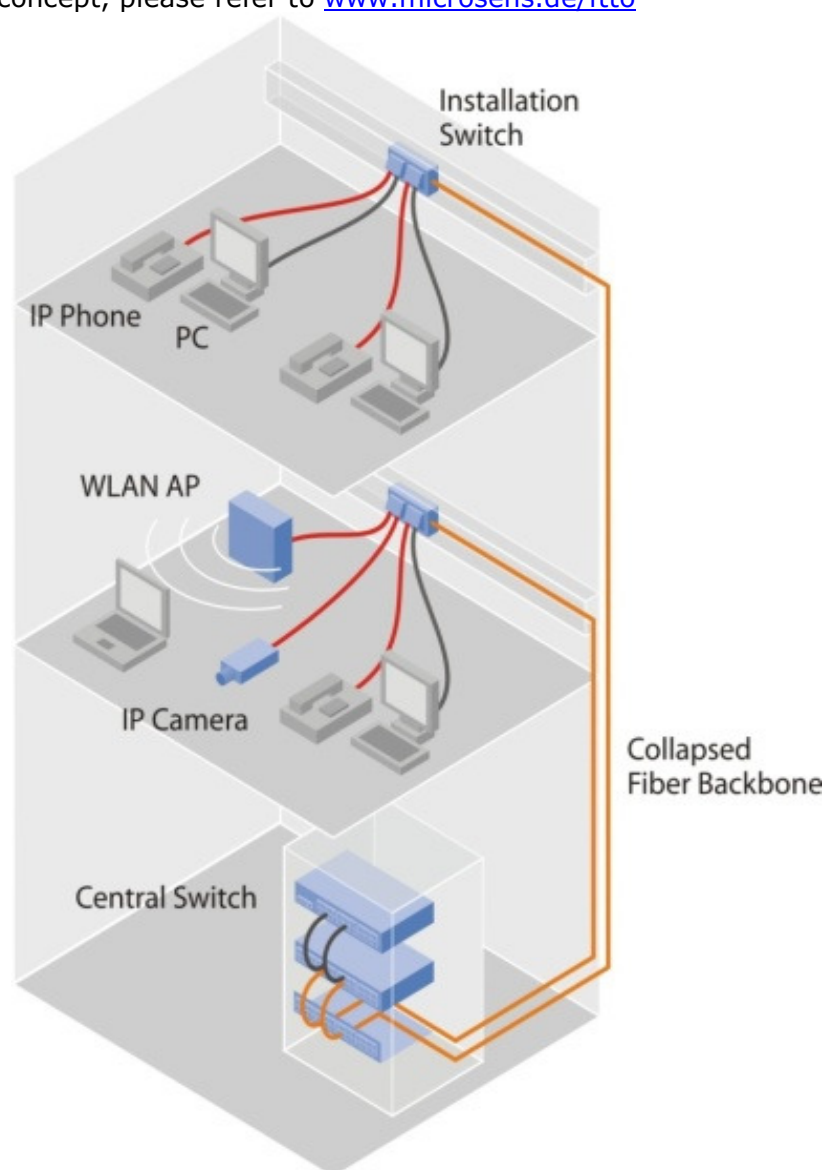

Application Diagramme FTTO Concept

2. Introduction to M45 Modular Technology

Future-orientated cabling concepts are distinguished primarily by their flexibility. With M45 modular technology, MICROSENS provides the most compact installation solutions for active network components currently available on the market.

M45 modular technology is built on the basic dimensions of 45 x 45 mm. This design is found all over the world and allows it to be deployed in both national and international installation systems. It is the smallest size to which a Schuko socket can be reduced. Alongside standard installation in device installation ducts and underfloor systems, desk and laboratory installation as well as room pillar and concealed installation are now widespread.

The main advantage of M45 modular technology is its cost efficiency compared to traditional systems – cutting installation costs by around 50%. The components no longer need to be fastened with screws, but are simply snapped into specially-designed device brackets or sockets (snap in). This considerably reduces installation times.

When using installation components, MICROSENS differentiates between horizontal and vertical models. The devices are supplied for a perfect fit – no need to make any alterations or waste time putting the equipment together on-site. This not only reduces the amount of time and effort required, but also significantly increases the durability of the components.



MICROSENS 6-port GbE Micro Switch
Generation 6



Micro Switch in cable duct
with 45 mm track



MICROSENS GbE Micro Access Point
MS441201M M45 model

M45 modular technology – never has it been easier or quicker to install and integrate equipment!

Module 45 Size Details

M45



M45-2

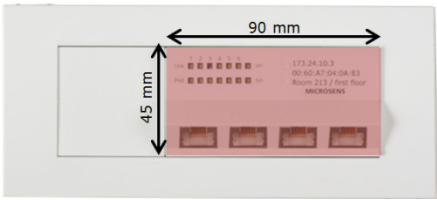

MICROSENS components available in this size:

- (excerpt)
- MS140033
- MS140174
- MS140150-GT

MICROSENS components available in this size:

- Micro Switches
- Micro Power Supply MS700750
- Micro Access Point MS442500M
- Micro Automation Gateway MS442500M

Installing an MS140029 Micro Switch Installation Adapter

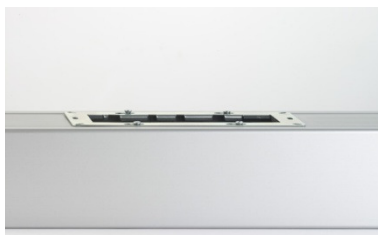

Screw the adapter plate onto the socket.



After connecting up the network and power supply, insert the Micro Switch through the adapter plate at an angle.



Then place the Switch into the allocated adapter plate opening.

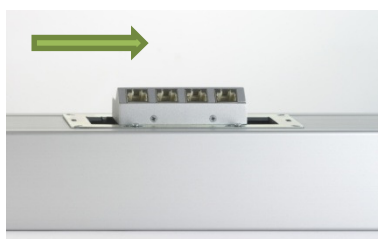

Snap the device onto the adapter plate.

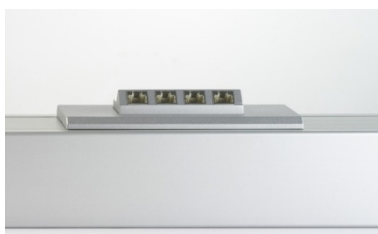

Install the plastic cover.

3. Greater Security for Your Micro Switch

The adapter plate allows the device to be installed or removed without the need for tools. However, in order to make the unauthorised removal of a Micro Switch more difficult, especially in a public environment, MICROSENS also offers an optional locking device set.

Step 1



First of all, the switch is installed and brought into position without the need for tools. In the illustrated example, however, the switch could be removed by simply sliding it sideways.

Step 2



To prevent being able to slide the switch over, the locking device is screwed onto the mounting plate at the designated position. Now the switch can no longer be removed without tools, i.e. tools are now needed to remove it.

Step 3



Where a mounting plate designed to take up to three modules is used, the next step is to insert a dummy module as shown in the illustration.

This step is not necessary, when mounting a plate to take up a double module.

Step 4



The cover frame is then added to finish off the installation.

The product No. of the locking device set, consisting of one locking device and two screws, is MS140099. This can be combined with an MS140029-xx, MS140069-xx, MS140040F2-xx, MS140040BR2-xx, MS140040HW3 or MS140040UP3 adapter plate.

	Description	Art. No.
	Locking device for MICROSENS 2-socket + 3-socket adapters, consisting of one locking plate and incl. 2 screws	MS140099

4. Device Installation Ducts and Conduits

For installation in a device installation duct where the nominal dimensions of the track exceed 45 mm, MICROSENS offers a series of adapter plates. The art of combining device brackets, resp. sockets with the desired device installation duct requires additional knowledge which MICROSENS will be familiarizing you with on the following pages.

Example of how to install an MS140029 adapter plate



Adapter plate + E2 socket
in an OBO BETTERMANN GEK Rapid80 system



Insert a Switch



Apply cover frame



Watch a video on
this product

4.1 Installation Set with Universal Device Brackets for Ducts with an Anchor Rail

The MICROSENS MS140040BR2 installation set is suitable for all device installation ducts with an anchor rail located at the rear of the duct where the devices are to be installed - be this in the shape of an anchor rail with a C-profile, a 35 mm combi-rail or a DIN rail.

This universal set replaces the device socket. Its open design offers plenty of room for power and network connections. The set is adjustable to compensate for different inner duct heights (47, 50, 52 or 55 mm). No further installation components are required.

The cover frame is designed to overlap the area cut out of the upper duct section (duct cover).

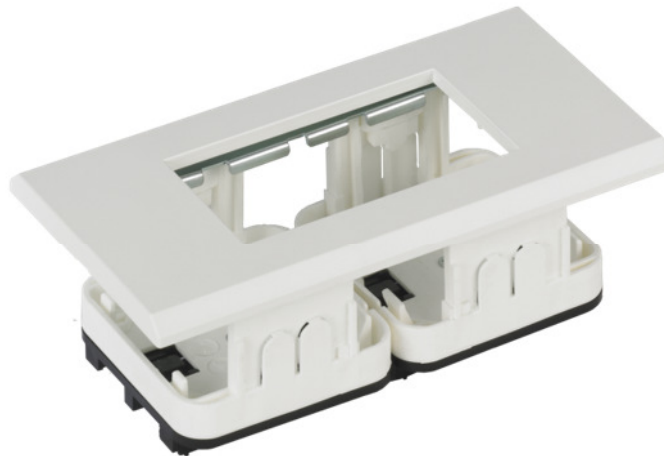

Watch a video on this product

Image	Description	Art. No.
	Installation set, consisting of a cover frame (168 x 85 mm), an adapter plate and 2x device brackets, pre-assembled Colour: Pure white	MS140040BR2
	Colour: Varnished aluminium	MS140040BR2-AL
	Colour: Graphite grey	MS140040BR2-GT
	Single cover frame Colour: Pure white	MS140070-RW
	Colour: Varnished aluminium	MS140070-AL
	Colour: Graphite grey	MS140070-GT

*Further colours upon request

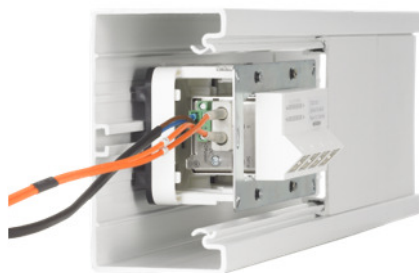

Installed on a C-profile anchor rail in a tealit duct

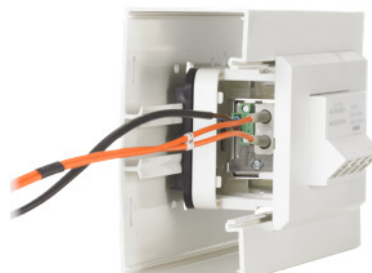

Installed on a 35mm combi rail in a GEK duct

4.2 Installation Set for Front-Locking Tehalit Ducts

The MS140040F2 set is ideal for all front-locking, steel device installation ducts manufactured by Hager (tehalit). This set, which replaces the device socket, has an open design, offering plenty of room for power and network connections. No further installation components are required. The cover frame fits flush with the upper duct, i.e. it does not overlap the cut-out section.

The set consists of a triple-socket bracket with a matching cover. To install a Micro Switch, an M45 dummy module, which is included in the set, is also required. An optional locking bar can also be used to secure the Micro Switch.



Image	Description	Art. No.
	Installation set, consisting of a 3-socket cover frame (184 x 86 mm), a front-locking mounting bracket, 1x M45 dummy module	MS140040F2
	Colour: Pure white (RAL 9010)	
	Colour: Varnished aluminium	MS140040F2-AL
	Colour: Graphite grey (RAL 7021)	MS140040F2-GT
	Locking device for MICROSENS 2-socket + 3-socket adapters, consisting of one locking plate and incl. 2 screws	MS140099

*Further colours upon request



Finished installation in a tehalit duct

4.3 Device Installation Ducts with Standard E2 Sockets

For the universal installation of MICROSENS installation components in standard ducts with E2 sockets, MICROSENS supplies an MS140029 installation set.

This two-component set consists of an adapter plate with an M45 track which allows a Micro Switch to be inserted without needing to use tools. This newly-designed adapter plate, which can optionally be used in combination with a locking device to secure a Micro Switch (please refer to MS140099), has now been additionally reinforced to make it resistant to bending. It also includes a cover frame which fits the switch perfectly.

Alongside the MICROSENS adapter set, an original E2 socket supplied by the respective cable duct manufacturer (not included in the set) is required for the installation. A table listing all the compatible E2 sockets is available on page 22 f.

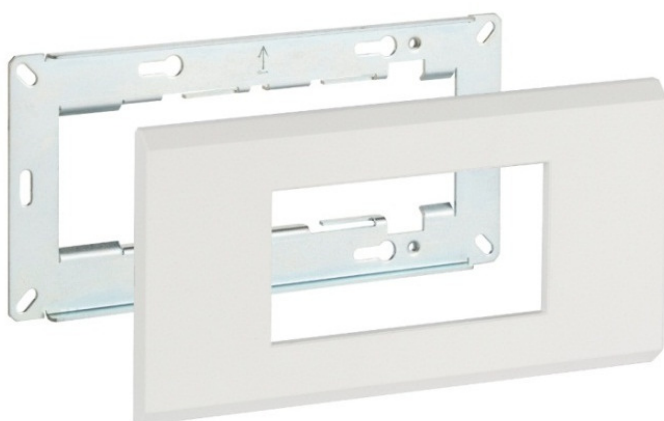

Watch a video on this product

Image	Description	Art. No.
	Universal installation set for an E2 socket, consisting of an adapter plate and a cover frame	
	Colour: Pure white	MS140029
	Colour: Varnished aluminium	MS140029-AL
	Colour: Graphite grey	MS140029-GT
	Single cover frame	
	Colour: Pure white	MS140070-RW
	Colour: Varnished aluminium	MS140070-AL
	Colour: Graphite grey	MS140070-GT
	Locking device for MICROSENS 2-socket + 3-socket adapters, consisting of one locking plate and incl. 2 screws	MS140099

*Further colours upon request



Micro Switch with cover, installed in an E2 socket

4.4 Flush Right Installation in an E2 Socket

Fiber optic cables only have a limited bending radius. MICROSENS now offers a solution which allows a Micro Switch to be installed flush right – thus making extra space for the fiber optic cabling.

The three-component set consists of an adapter plate with a 45 mm track which allows a Micro Switch to be inserted without needing to use tools. The plate has been specially reinforced for improved bend resistance and stability. A locking device can also be installed to secure the Micro Switch. In addition, the set also includes a dummy module.

Not included in the set are compatible E2 sockets, such as those manufactured by Legrand, Bticino and OBO Bettermann.

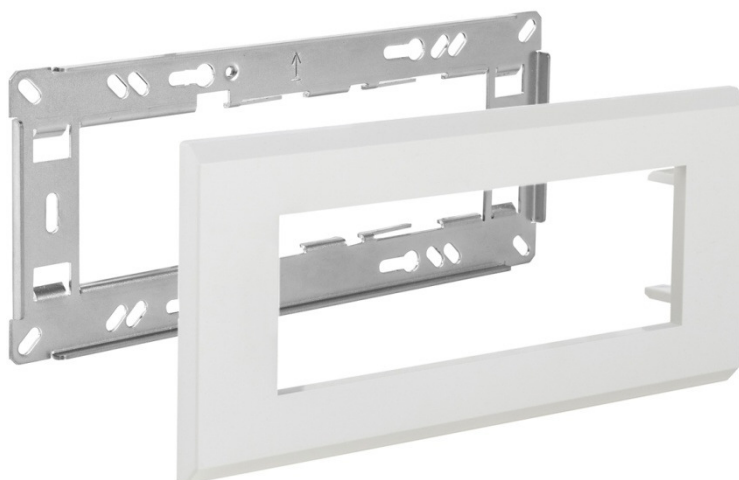

Image	Description	Art. No.
	Installation set, consisting of a cover frame (184 x 86 mm), a mounting bracket, 1x M45 dummy module	
	Colour: Pure white	MS140069
	Colour: Varnished aluminium	MS140069-AL
	Colour: Graphite grey	MS140069-GT
	Locking device for MICROSENS 2-socket + 3-socket adapters, consisting of one locking plate and incl. 2 screws	MS140099

*Further colours upon request



4.5 Installation Set for Front-Locking Kleinhuis Ducts

The MS140047F-KH and MS140047F3-KH sets are suitable for all front-locking device installation ducts manufactured by Kleinhuis. These sets, which replace the device socket, have an open design, offering plenty of room for power and network connections. No further installation components are required. The cover frame fits flush with the upper duct, i.e. it does not overlap the cut-out section.

The **MS140047F-KH** set is based on a double socket bracket with a matching cover. This installation set is only suitable for usage with a G6 Switch. The **MS140047F3-KH** set is based on a triple-socket bracket with a matching cover. To install a Micro Switch, an M45 dummy module, which is included in the set, is also required. This installation set is suitable for all Micro Switch generations (G3..G6).

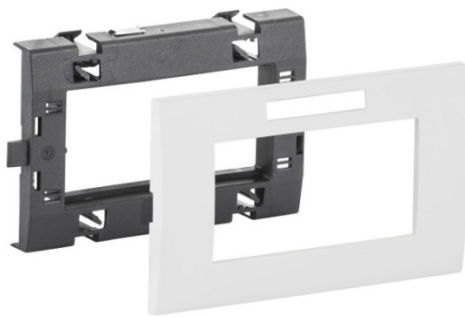

MS140047F-KH



MS140047F3-KH

Image	Description	Art. No.
	Installation set, consisting of a 2-socket cover frame and a front-locking mounting bracket	
	Colour: Pure white	MS140047F-KH
	Colour: Varnished aluminium	MS140047F-KH-AL
	Colour: Graphite grey	MS140047F-KH-GT
	Installation set, consisting of a 3-socket cover frame, a front-locking mounting bracket, 1x M45 dummy module	
	Colour: Pure white	MS140047F3-KH
	Colour: Varnished aluminium	MS140047F3-KH-AL
	Colour: Graphite grey	MS140047F3-KH-GT

*Further colours upon request



MS140047F-KH installed in a Kleinhuis duct



MS140047F3-KH installed in a Kleinhuis duct

4.6 Installation Set for Front-Locking Niedax Ducts

The MS140047F-ND and MS140047F3-ND sets are suitable for all front-locking, steel device installation ducts manufactured by Niedax. These sets, which replace the sockets, have an open design, offering plenty of room for power and network connections. No further installation components are required. The cover frame fits flush with the upper duct, i.e. it does not overlap the cut-out section.

The **MS140047F-ND** is based on a double socket bracket with a matching cover. This installation set is only suitable for usage with a G6 Switch. The **MS140047F3-ND** set is based on a triple-socket bracket with a matching cover. To install a Micro Switch, an M45 dummy module, which is included in the set, is also required. This installation set is suitable for all Micro Switch generations (G3..G6).

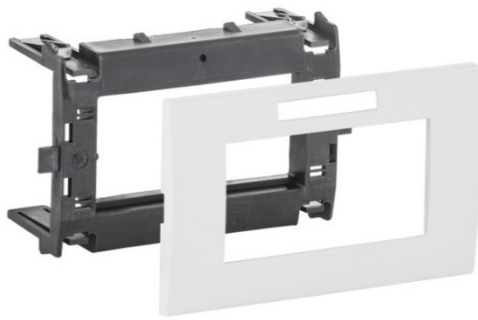

MS140047F-ND



MS140047F3-ND

Image	Description	Art. No.
	Installation set, consisting of a 2-socket cover frame and a front-locking mounting bracket	
	Colour: Pure white	MS140047F-ND
	Colour: Varnished aluminium	MS140047F-ND-AL
	Colour: Graphite grey	MS140047F-ND-GT
	Installation set, consisting of a 3-socket cover frame, a front-locking mounting bracket, 1x M45 dummy module	
	Colour: Pure white	MS140047F3-ND
	Colour: Varnished aluminium	MS140047F3-ND-AL
	Colour: Graphite grey	MS140047F3-ND-GT

*Further colours upon request























MS140047F-ND installed in a Niedax duct





MS140047F3-ND installed in a Niedax duct





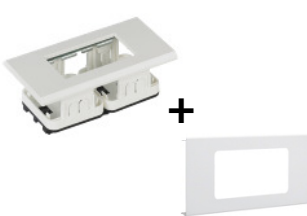
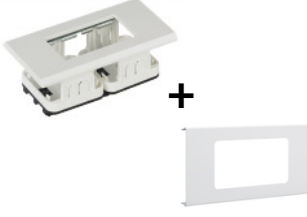
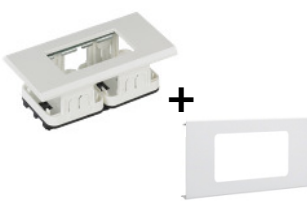

4.7 Tehalit Device Installation Ducts



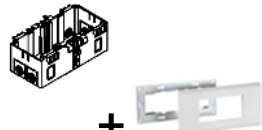
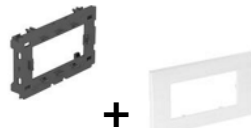
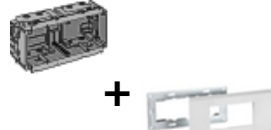

Duct	Socket/Bracket	Suitable MICROSENS Installation Set	Image
tehalit.BRS duct profile, 70 mm high, 80 mm top, molded parts, front-locking device installation Type: BRS65xxx	Included in the MICROSENS set	MS140040F2	
tehalit.BRS duct profile, 85 mm high, 80 mm top, molded parts, front-locking device installation Type: BRS85xxx	Included in the MICROSENS set	MS140040F2	
tehalit.BRS duct profile, 100 mm high, 80 mm top, molded parts, front-locking device installation Type: BRS100xxx	Included in the MICROSENS set	MS140040F2	
tehalit.BRA duct profile, 70 mm high, 80 mm top, molded parts, front-locking device installation Type: BRA65xxx(w/o 65b)	Included in the MICROSENS set	MS140040BR2	
tehalit.BR duct profile, 70 mm high, molded parts, C-Profile device installation Type: BR70100	Included in the MICROSENS set	MS140040BR2	
tehalit.BR duct profile double compartment, molded parts, C-Profile device installation Type: BR70214	Included in the MICROSENS set	MS140040BR2	
tehalit.BRN duct profile, 70 mm high, molded parts, C-Profile device installation Type: BRN70xxx	Included in the MICROSENS set	MS140040BR2	

Duct	Socket/Bracket	Suitable MICROSENS Installation Set	Image
tehalit.BRHN duct profile, 70 mm high, molded parts, C-Profile device installation Type: BRHN70xxx	Included in the MICROSENS set	MS140040BR2	
tehalit.BRH duct profile, 70 mm high, molded parts, C-Profile device installation Type: BRH70132	Included in the MICROSENS set	MS140040BR2 With an MS140075-BRH cover	 + 
tehalit.BR duct profile, 70 mm high, molded parts, C-Profile device installation Type: BR70130	Included in the MICROSENS set	MS140040BR2 With an MS140075 cover	 + 
tehalit.BR duct profile, 85 mm high, molded parts, C-Profile device installation Type: BR85130	Included in the MICROSENS set	MS140040BR2 With an MS140075 cover	 + 
tehalit.BRS duct profile, 70 mm high, 120 mm top, molded parts, C-Profile device installation Type: BRS65xxxB	Included in the MICROSENS set	MS140040BR2 With an R9282xxx cover manufactured by Hager	 + 
tehalit.BRS duct profile, 85 mm high, 120 mm top, molded parts, C-Profile device installation Type: BRS85210B	Included in the MICROSENS set	MS140040BR2 With an R9282xxx cover manufactured by Hager	 + 
tehalit.BRS duct profile, 100 mm high, 120 mm top, molded parts, C-Profile device installation Type: BRS100210B	Included in the MICROSENS set	MS140040BR2 With an R9282xxx cover manufactured by Hager	 + 

Duct	Socket/Bracket	Suitable MICROSENS Installation Set	Image
tehalit.BRA duct profile, 70 mm high, 120 mm top, molded parts, C-Profile device installation Type: BRA65xxxB	Included in the MICROSENS set	MS140040BR2 With a BRA1202Rxxx cover manufactured by Hager	
tehalit.BRH duct profile, 70 mm high, molded parts, C-Profile device installation Type: BRH70172	Included in the MICROSENS set	MS140040BR2 With an R6492xxx cover manufactured by Hager	
tehalit.BR duct profile, 70 mm high, molded parts, C-Profile device installation Type: BR70170	Included in the MICROSENS set	MS140040BR2 With an L917290xx cover manufactured by Hager	
tehalit.BR duct profile, 85 mm high, molded parts, C-Profile device installation Type: BR85170	Included in the MICROSENS set	MS140040BR2 With an L917290xx cover manufactured by Hager	
tehalit.BR duct profile double compartment, molded parts, C-Profile device installation Type: BR70214	Included in the MICROSENS set	MS140040F2	

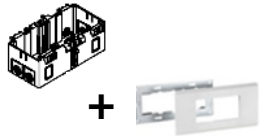
4.8 Device Installation Ducts Manufactured by OBO BETTERMANN

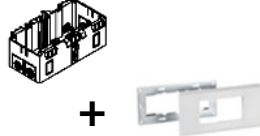
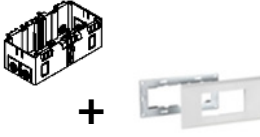
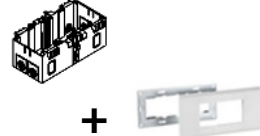
Duct	Socket/Bracket	Suitable MICROSENS Installation Set	Image
Rapid 80 device installation duct made of plastic, steel or aluminium, various models and sizes available	Set replaces socket 71GD7 Recommended model No need to cut holes out for cable routing	MS140038-RP80 2-component set	
Rapid 80 device installation duct made of plastic, steel or aluminium, various models and sizes available	Set replaces socket 71GD7 Recommended model No need to cut holes out for cable routing	MS140039-RP80 3-component set	
Rapid 80 device installation duct made of plastic, steel or aluminium, various models and sizes available	Front-locking device installation socket manufactured by OBO BETTERMANN Type: 71GD7	MS140029	
Rapid 45 device installation duct made of plastic, steel or aluminum, various models and sizes available	No socket required, the Micro Switch fits the 45 mm rail of the Rapid45 duct without the need for further accessories	Not required	
BK70xxx (older models)	Socket for PVC ducts from the OBO BETTERMANN GEK series Type: 2390 8T2	MS140029	
GEK 70xxx ducts (older models)	Not required	MS140035	
GES 70xxx ducts (older models)	GED-2	MS140029	
GEA 70xxx ducts PVC (older models)	GED-2	MS140029	

Duct	Socket/Bracket	Suitable MICROSENS Installation Set	Image
BS70xxx (older models)	Socket for PVC ducts from the OBO BETTERMANN GEK series Type: 2390 8T2	MS140029	
BBA70xxx (older models)	Not required	MS140040BR2	
BBST70xxx (older models)	Not required	MS140040BR2	
BS90xxx (older models)	Socket for PVC ducts from the OBO BETTERMANN GEK series Type: 2390 8T2	MS140029	
GEA 55110 S (older models)	Socket for PVC ducts from the OBO BETTERMANN GEK series Type: 2390 8T2	MS140029	
GEA 55135 O (older models)	Socket for PVC ducts from the OBO BETTERMANN GEK series Type: 2390 8T2	MS140029	
6 WIK 2 (older model manufactured by Ackermann)	Not required	MS140040BR2	

4.9 Socket Overview - Sorted by Duct Manufacturer



Baukulit

Image	Type/Article No.	Description	Suitable MICROSENS Installation Set
	KFR/44 362-104 Height: 44 mm	<ul style="list-style-type: none"> • Front-locking socket • Manufacturer Spelsberg 	MS140029



Dahl

Image	Type/Article No.	Description	Suitable MICROSENS Installation Set
	GK/D	<ul style="list-style-type: none"> • For Dahl GKB and LKO ducts • No longer available 	MS140029
	MS140049	<ul style="list-style-type: none"> • For Dahl ducts w/o mounting rail • Attached to the rear wall of the duct 	MS140029



GGK

Image	Type/Article No.	Description	Suitable MICROSENS Installation Set
	GED 50/2	<ul style="list-style-type: none"> • For installation of 80 mm devices in cable routing duct systems and device installation duct systems with DIN mounting rails 	MS140040BR2 * replaces socket
	KFR/44 362-104 Height: 44 mm	<ul style="list-style-type: none"> • Front-locking socket • Manufacturer Spelsberg 	MS140029



Hager (tehalit)

Image	Type/Article No.	Description	Suitable MICROSENS Installation Set
	L4719SCHW EAN = 4 012740 264549 142 x 71 x 55	<ul style="list-style-type: none"> For device installation ducts with an upper section ≤ 100 mm and C-rail, e.g. BR70130 	MS140029 * MS140040BR2 is recommended when purchasing new
	G2737 EAN = 4 012740 885379 142 x 64 x 50	<ul style="list-style-type: none"> For device installation ducts with an 80 mm upper section and C-rail, e.g. BR70100 and BR 70214 	MS140029 * MS140040BR2 is recommended when purchasing new
	G2860 EAN= 4012740220057 142 x 64 x 42	<ul style="list-style-type: none"> Device installation socket, front-locking, double, made from polyamide, halogen-free, old no. G2705 	MS140029



Kleinhuis

Image	Type/Article No.	Description	Suitable MICROSENS Installation Set
	KED265 142 x 71 x 59	<ul style="list-style-type: none"> For BS ducts with 80 mm and 112 mm upper cable section 	MS140040BR2 * replaces socket
	KD2/50 382 450 01 142 x 71 x 59	<ul style="list-style-type: none"> For BS ducts with 80 mm and 112 mm upper cable section Manufacturer Spelsberg 	MS140040BR2 * replaces socket
	KED65D	<ul style="list-style-type: none"> For BS ducts with 80 mm and 112 mm upper cable section 2 required per Switch 	MS140029





Niedax

Image	Type/Article No.	Description	Suitable MICROSENS Installation Set
	GDHR 50-2 142 x 82 x 52	<ul style="list-style-type: none"> Front-locking, GK78 device installation ducts, installation width 78 mm, steel/aluminium 	MS140029
	KD2 cam lock 12 mm 362 404 01	<ul style="list-style-type: none"> Front-locking, GK78 device installation ducts, installation width 78 mm, steel/aluminium Height: 44 mm Manufacturer Spelsberg 	MS140029
	KD2/52 (type 52 mm) 382 052 01 142 x 70 x 56	<ul style="list-style-type: none"> For GK100 device installation ducts, installation width 110 mm, steel Manufacturer Spelsberg 	MS140040BR2 * replaces socket



Nowaplast

Image	Type/Article No.	Description	Suitable MICROSENS Installation Set
	KD2/52 382 052 01 142 x 70 x 56	<ul style="list-style-type: none"> Device installation ducts PVC/aluminium/steel, FB device installation ducts, HSG device installation ducts Manufacturer Spelsberg 	MS140040BR2 * replaces socket
	KD2 hook lock 362 104 01 Height: 44 mm	<ul style="list-style-type: none"> Front-locking, BR device installation ducts, installation width 80 mm, BR-PVC, BR-aluminium, BR-steel profiled Manufacturer Spelsberg 	MS140029
	KD2 cam lock 12 mm 362 194 01	<ul style="list-style-type: none"> Front-locking, BR device installation ducts, installation width 80 mm, BR-PVC, BR-aluminium, BR-steel profiled Manufacturer Spelsberg 	MS140029

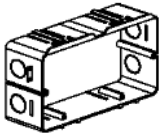
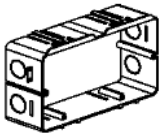
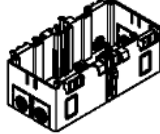

**OBO
BETTERMANN**

Image	Type/Article No.	Description	Suitable MICROSENS Installation Set
	71GD2 35172NV 160 x 74 x 42.5	<ul style="list-style-type: none"> Front-locking 	MS140029
	71GD3 35172PV 150 x 74 x 47.5	<ul style="list-style-type: none"> Front-locking 	MS140029
	71GD7 37087BV 142 x 76 x 51	<ul style="list-style-type: none"> Front-locking, for S990 cover series 	MS140029
	71GD9 142 x 76 x 51	<ul style="list-style-type: none"> Front-locking, for S990 cover series 	MS140029
	7GD8Z 35172V4 142 x 71 x 62	<ul style="list-style-type: none"> Type 55 mm for 110 mm duct systems with C-rail 	MS140029 * MS140040BR2 is recommended when purchasing new
	GED-2 (PVC) 6257 60 5 141 x 78 x 48	<ul style="list-style-type: none"> Steel/aluminium device installation ducts GES/GEA series 	MS140029
	GED-2 HF (ABS) 6257 62 5 141 x 78 x 48	<ul style="list-style-type: none"> Steel/aluminium device installation ducts GES/GEA series 	MS140029
	2390/8T2 6270 77 8 141 x 81 x 52	<ul style="list-style-type: none"> PVC device installation ducts GEK series 	MS140029

Rehau

Image	Type/Article No.	Description	Suitable MICROSENS Installation Set
	KD2/55	<ul style="list-style-type: none"> • Device installation ducts PVC/aluminium/steel, signo BK, BS, BA, FBK window sill ducts • Manufacturer Spelsberg 	MS140040BR2
	382 055 01		* replaces socket
	142 x 70 x 59		
	KD2 hook lock	<ul style="list-style-type: none"> • Device installation ducts PVC/aluminium/steel, signo BK, BS, BA • Manufacturer Spelsberg 	MS140040BR2
	362 104 01		* replaces socket
	142 x 70 x 59		

Spelsberg

Image	Type/Article No.	Description	Suitable MICROSENS Installation Set
	TA55-2	<ul style="list-style-type: none"> • Type 55 mm for 110 mm duct systems with C-rail 	MS140040BR2
	392 055 01		* replaces socket
	142 x 70 x 61		
	TA50-2 (Type 50 mm)	<ul style="list-style-type: none"> • For FB device installation ducts PVC 	MS140040BR2
	392 050 01		* replaces socket
	142 x 70 x 56		

Stago

Image	Type/Article No.	Description	Suitable MICROSENS Installation Set
	KFR/44	<ul style="list-style-type: none"> • Front-locking socket • Manufacturer Spelsberg 	MS140029
	362-104		
	Height: 44 mm		

Thorsman

Image	Type/Article No.	Description	Suitable MICROSENS Installation Set
	MIB-A2	<ul style="list-style-type: none"> • Front-locking socket • Available at MICROSENS under the art. No. MS140037V2-5 	MS140029
	142 x 79 x 45		

Van Geel

Image	Type/Article No.	Description	Suitable MICROSENS Installation Set
	KFR/44	<ul style="list-style-type: none"> • Front-locking socket • Manufacturer Spelsberg 	MS140029
	362-104		
	Height: 44 mm		
	Art. No.: 8510102	<ul style="list-style-type: none"> • Socket for duct systems with anchor rail (e.g. type GWO-4) • Manufacturer: Legrand • Available at MICROSENS under the art. No.: MS140043 	MS140029

* The sides of some sockets are fitted with a screw fastening mechanism which is required to secure the socket in the duct. The sides of these sockets should, therefore, not be altered. However, as the Switch requires sufficient space for the cabling, we recommend alternatively using an MS140040BR2 set (socket not required).

4.10 PoE Power Supply Installation in a Device Installation Duct

Installation components with Power-over-Ethernet functionality require a 48 VDC power supply (resp. 54 VDC for PoE+). This is generally achieved by using an external power supply which is integrated during installation.



PoE+ installable
power supply
MS700710

4.10.1 Installation on a C-profile, 35 mm combi-rail or 35 mm DIN rail

MICROSENS offers a universal installation adapter for the MS700710 power supply which makes light work of installation on a C-profile, 35 mm combi-rail or 35 mm DIN rail. The installation adapter is screwed onto the power supply and is then simply snapped onto the respective profile. This is shown in the illustration below. The installation set (power supply not included) can be ordered by quoting the article No.: **MS-140075-UNI**. A combi-set, consisting of an MS700710 power supply and an MS140075-UNI installation set can be ordered by quoting the article No.: **MS700710-UNI**.



MS700710 installed on a combi-rail
using an MS140075-UNI



MS700710 power supply installed on a
C-profile using an MS140075-UNI

4.10.2 Installation in a Front-Locking Tehalit Duct

MICROSENS offers a special installation set for front-locking tehalit ducts made of steel. This bracket - with the power supply attached to it - is simply snapped onto the assembly track and then covered over by the upper duct section. This installation set can be ordered by quoting the following product number: **MS140075-10F**.



MS700710 power supply installed in a tehalit duct using an MS140075-10F power supply bracket

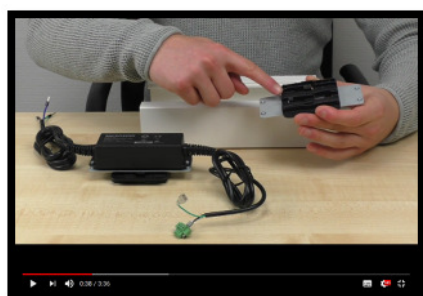

Videos of our MS140075-UNI
and MS140075-10F products









4.10.3 Magnetic Installation

For magnetic surfaces, MICROSENS offers the option of installing an MS700701 power supply using an MS140075-MAG installation set. This installation set has four neodymium magnets attached to the bottom for really quick and easy installation on any magnetisable surface.

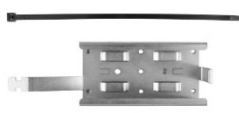
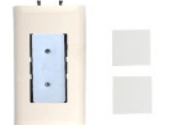

MS700701 slotted onto an MS140075-MAG installation plate

Image	Description	Art. No.
	Power supply 100-230 VAC / 54 VDC, 1.35 A, 65 W, open wire ends, fixed cable, conducted grounding Input: 3x 1.5mm Output: 1x DC screw terminal	MS700710
	54V/1.2A 65W for PoE+, 3x1.5 mm ² with pre-installed WAGO plug	MS700710-WG
	54V/1.2A 65W for PoE+, 3x1.5 mm ² with pre-installed Wieland plug	MS700710-WL
	MS700710 power supply, incl. universal installation set for C-profile, 35 mm combi-rail and 35 mm DIN rail installation 54V/1.2A 65W for PoE+	MS700710-UNI
	MS700710 power supply, incl. universal installation set for C-profile, 35 mm combi-rail and 35 mm DIN rail installation 54V/1.2A 65W for PoE+, 3x1.5 mm ² with pre-installed WAGO plug	MS700710-UNI-WG
	MS700710 power supply, incl. universal installation set for C-profile, 35 mm combi-rail and 35 mm DIN rail installation 54V/1.2A 65W for PoE+ 3x1.5 mm ² cable with pre-installed Wieland connector at one end	MS700710-UNI-WL
	Universal installation set for MS700710 power supply, designed for C-profile, 35 mm combi-rail and 35 mm DIN rail installation	MS140075-UNI
	MS700710 power supply, incl. installation set for front-locking Hager (tehalit) steel device installation ducts with 80 mm cover track, pre-installed 54V/1.2A 65W for PoE+	MS700710-FTH
	MS700710 power supply, incl. installation set for front-locking Hager (tehalit) steel device installation ducts with 80 mm cover track, pre-installed 54V/1.2A 65W for PoE+ 3x1.5 mm ² cable with pre-installed WAGO connector at one end	MS700710-FTH-WG
	MS700710 power supply, incl. installation set for front-locking Hager (tehalit) steel device installation ducts with 80 mm cover track, pre-installed 54V/1.2A 65W for PoE+ 3x1.5 mm ² cable with pre-installed Wieland connector at one end	MS700710-FTH-WL
	MS700710 power supply, incl. installation set for front-locking Hager (tehalit) steel device installation ducts with 80 mm cover track, pre-installed	MS140075-10F
	Power supply installation set for wall duct socket. Set consists of an installation plate, a power supply bracket, a cover frame and 2x M45 dummy modules	MS140076

Image	Description	Art. No.
	Installation set for installing an MS700701 using magnets. Set consists of a magnetic bracket with strain relief and cable tie	MS140075-MAG
	Installation set for Legrand device installation duct systems, consisting of a front-locking adapter, a cover frame, 2x M45 dummy modules, pre-installed	
	Installation set for Legrand device installation duct systems, consisting of an MS700710 power supply, a front-locking adapter, a cover frame, 2x M45 dummy modules, pre-installed	MS700710-LGF
	Installation set for Legrand device installation duct systems, consisting of an MS700710 power supply, a front-locking adapter, a cover frame, 2x M45 dummy modules, pre-installed 54V/1.2A 65W for PoE+ 3x1.5 mm ² cable with pre-installed WAGO connector at one end	MS700710-LGF-WG
	Installation set for Legrand device installation duct systems, consisting of an MS700710 power supply, a front-locking adapter, a cover frame, 2x M45 dummy modules, pre-installed 54V/1.2A 65W for PoE+ 3x1.5 mm ² cable with pre-installed Wieland connector at one end	MS700710-LGF-WL
	WAGO-WINSTA® MIDI socket, fits WAGO connectors	MS190261-F
	Wieland Gesis connector socket, fits Wieland connectors	MS190260-F

5. Underfloor Installation

With the introduction of underfloor installation in modern office environments, it is now easy to install inconspicuous power outlets, passive data connections and active installation components throughout the building – with minimal space requirements.

For underfloor installation, we recommend using a vertical MICROSENS installation component model. These models offer optimum cabling management technology without RJ-45 cables getting in the way of neighbouring installation units. The TP connector cables point directly to the through openings in the floor tank cover.

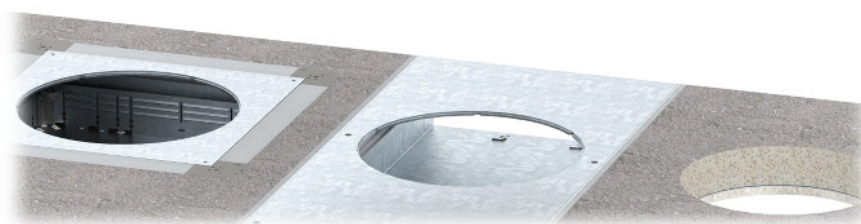

OBO BETTERMANN underfloor device socket, including a MICROSENS Micro Switch and an MS140027 installation set







5.1 Installation Sets for OBO Underfloor Systems

The MS140026 and MS140027 sets are needed to install M45 modular MICROSENS installation components in an OBO BETTERMANN (formerly Ackermann) underfloor system. Both sets can accommodate three M45 modules. Which set is required depends on the size of the underfloor tank.



Image	Description	Art. No.
	Installation set, consisting of one socket (length: 165 mm), one device bracket and 1x M45 dummy module UF Scope of delivery: Parts pre-assembled Installation set specially designed for G6 Switch	MS140026-G6
	Installation set, consisting of one socket (length: 165 mm), one device bracket and 1x M45 dummy module UF Scope of delivery: Parts pre-assembled Installation set for G3-G5 Switch	MS140026
	Installation set, consisting of one socket (length: 208 mm), one device bracket, 1x M45 dummy module UF, 1x socket cover Scope of delivery: Parts pre-assembled Installation set specially designed for G6 Switch	MS140027-G6
	Installation set, consisting of one socket (length: 208 mm), one device bracket, 1x M45 dummy module UF, 1x socket cover Scope of delivery: Parts pre-assembled	MS140027
	Replacement/individual component for MS140026, consisting of a device bracket and an M45 dummy module UF	MS140024
	Replacement/individual component for MS140027, consisting of a device bracket, 1x M45 dummy module UF, socket cover	MS140025
	Replacement/individual component for MS140027, consisting of one device bracket	MS140027-1

5.2 OBO Underfloor Tanks (formerly Ackermann)

Socket	Image	Description	Suitable MICROSENS installation set
GES2		For installation of 1x MS140026	MS140026, MS140026-G6
GES4		For installation of up to 2x MS140026	MS140026, MS140026-G6
GES6		For installation of up to 3x MS140026	MS140026, MS140026-G6
GESR7		For installation of 2x MS140026 and 1x MS140027	MS140026, MS140026-G6 MS140027, MS140027-G6
GES9		For installation of up to 3x MS140027	MS140027 MS140027-G6
GRAF9		For installation of up to 3x MS140027	MS140027 MS140027-G6

MICROSENS Micro Switch in OBO BETTERMANN Floor Tank



Floor tank (open)



Floor tank (closed)

5.3 electraplan Supply Units

All the electraplan supply units listed below are used in combination with an MS140021-45 installation set. The casing included in the set is fitted with a 45 mm snap-on rail to which all MICROSENS installation components can be simply attached – without the need for further tools.

For older electraplan supply units ("hinged cover"), which were available until 2008, you will need to use an MS140021-AB set which includes a socket specially designed to match this particular model.



Supply Unit	Image	Description
VR10		For installation of 1x MS140021-45
VR12		For installation of up to 3x MS140021-45
VANR12		For installation of up to 3x MS140021-45
VQ12		For installation of up to 3x MS140021-45
EKQ12		For installation of up to 3x MS140021-45

Ordering Information

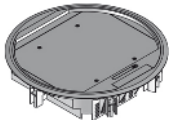
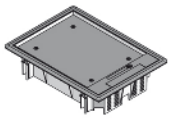
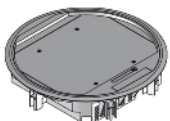
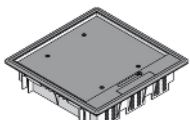

Image	Description	Art. No.
	Installation set for Hager (electraplan), consisting of a socket, snap-on rail and 2x M45 dummy modules UF	MS140021-45

5.4 PUK Underfloor Systems

All the PUK underfloor systems listed below are used in combination with an **MS140121-KU** installation set. This set includes a casing which is fitted with a 45 mm snap-on rail to which all M45 installation components can be simply attached – without the need for further tools.



Supported Underfloor Systems

Type	Image	Description
UEKD2-R		For installation of up to 2x MS140121-KU
UEBD2-R		
UEKD2-V		For installation of up to 2x MS140121-KU
UEBD2-V		
UEKD3-R		For installation of up to 3x MS140121-KU
UEBD3-R		
UEKD3-V		For installation of up to 3x MS140121-KU
UEBD3-V		
UEKDD-V-E		For installation of up to 3x MS140121-KU

Ordering Information

Image	Description	Art. No.
	Three-component installation set for PUK, consisting of one socket and 2x M45 dummy modules UF	MS140121-KU



MS140121-KU installation set for PUK underfloor systems



Micro Switch inserted into an MS140121-KU installation set

5.5 Installation Set for PUK Underfloor Systems with Increased PoE Requirements

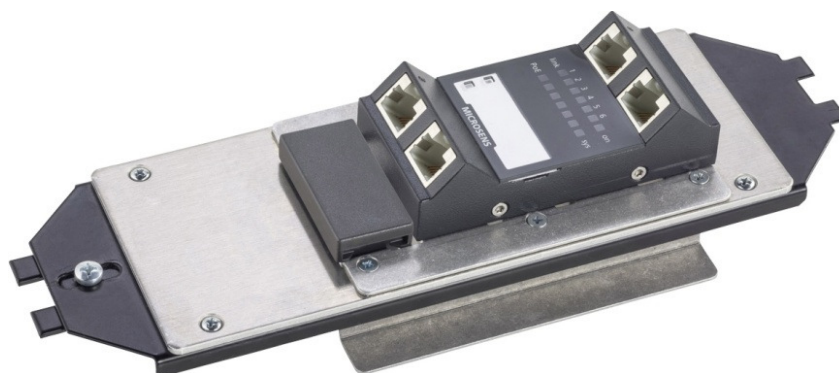

MICROSENS has specially designed an installation set for PUK underfloor systems to distribute heat more effectively. The installation set is equipped with a 45 mm snap-on rail to which all M45 installation components can be simply attached – without the need for further tools.

The set includes a metal mounting bracket and a half-size M45 dummy module.



Micro Switch attached to an MS140121-GT

Ordering Information

Image	Description	Art. No.
	Two-component installation set for PUK, consisting of a device bracket and a half-size M45 dummy module PW	MS140121
	Two-component installation set for PUK, consisting of a device bracket and a half-size M45 dummy module GT	MS140121-GT



MS140121 device bracket without a dummy module

5.6 Underfloor PoE Power Supply Installation

The implementation of Power-over-Ethernet functionality requires a 48 VDC power supply (resp. up to 54 VDC in the case of PoE+) and an adequate power budget. As a rule, external power supplies, which can be integrated during installation, are used.

When implementing an underfloor PoE+ system, there are various different options for installing the respective power supply models.

Installing an Installable Power Supply in an Underfloor Environment

Due to its compact dimensions and specific properties, the flexible MS700710 installable power supply is suitable for placement in a raised floor, thus not robbing the underfloor configuration of valuable installation space. Optionally, the MS700710-UNI model can be used. This is simply attached to an existing C-profile anchor rail, resp. DIN rail, using its integrated C-profile adapter. Also practical: The MS700710 can simply be placed inside the cable tray.



Apart from being used in a raised floor scenario, another typical application is positioning the device underneath the underfloor duct (assuming the environmental conditions allow this). In this case, the bottom of the power supply is installed, resp. screwed/riveted into place below the casing (the casing containing the Micro Switch is the easiest one to use) using the integrated mechanism.

When implementing the device in a casing inside the selected underfloor duct, attention should be paid to the fact that, due its dimensions, the MS700710 generally requires all the space provided in one casing in the underfloor systems presented in this document. In this case, it is possible to directly access the power supply.







MS700710-UNI attached to a C-profile (DIN) in a raised floor environment



MS700710 installed below an MS140027-G6, riveted into place

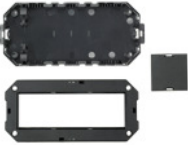

MS700710 in MS140027-G6

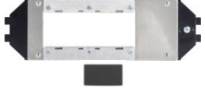
Image	Description	Art. No.
OBO Bettermann/Ackermann		
	Installation set, consisting of one socket (length: 165 mm), one device bracket and 1x M45 dummy module UF Scope of delivery: Parts pre-assembled	MS140026
	Installation set, consisting of one socket (length: 208 mm), one device bracket, 1x M45 dummy module UF, 1x socket cover Scope of delivery: Parts pre-assembled Installation set specially designed for G6 Switch	MS140027-G6
Hager/tehalit		
	Installation set for Hager (electraplan), consisting of a socket, a snap-on rail and 2x M45 dummy modules UF	MS140021-45
PUK		
	Three-component installation set for PUK, consisting of one socket and 2x M45 dummy modules UF	MS140121-KU
	Two-component installation set for PUK, consisting of a device bracket and a half-size M45 dummy module PW (RAL 9010)	MS140121
	Two-component installation set for PUK, consisting of a device bracket and a half-size M45 dummy module GT (RAL 7021)	MS140121-GT

6 Modular Chassis for Universal Applications

6.1 GT Chassis

The modular GT chassis from MICROSENS, which can be deployed in a large variety of applications, is the optimal installation solution for all workplaces which are difficult to connect up to a device installation duct or floor tank.

Universal applications include, for example:

- Wall/surface mounting
- Installation directly on a desk
- Mounting underneath the desk top
- Raised floor installation

The whole design of the GT chassis is aligned to M45 components - both the front panel and access points at the sides. Various lengths are available, in steps corresponding to the 45 modules. The unit can be installed either horizontally or vertically using corresponding installation accessories. Please refer to pages 45 and 48 f. for details on matching accessories, such as cable feeders and corresponding installation brackets.

Upon request, individual, ready-to-use customer-specific configurations can be built and supplied by MICROSENS. You can also contact MICROSENS directly for support in configuring the solution you are looking for.



Image	Description	Art. No.	
	4-slot GT chassis, incl. 2x M45 dummy modules	MS140131GT-4	
	5-slot GT chassis, incl. 2x M45 dummy modules	MS140131GT-5	
	6-slot GT chassis, incl. 2x M45 dummy modules	MS140131GT-6	
	7-slot GT chassis, incl. 2x M45 dummy modules	MS140131GT-7	
	8-slot GT chassis, incl. 2x M45 dummy modules	MS140131GT-8	
	MS140131GT-x	9-slot GT chassis, incl. 2x M45 dummy modules	MS140131GT-9
		10-slot GT chassis, incl. 2x M45 dummy modules	MS140131GT-10
		11-slot GT chassis, incl. 2x M45 dummy modules	MS140131GT-11

*For accessories, please refer to pages 45 and 48 f.

Several free M45 modular slots are required to install a PoE+-capable power supply in a GT chassis. When installing a power supply together with a Micro Switch, this means that a minimum number of M45 modular slots are required.

Depending on the power supply used, the following space is required in the chassis:

- MS700710: 4 additional modular slots (please refer to the image below)
- MS700750: 3 additional modular slots
- MS700701: 3 additional modular slots



Micro Switch installed with a power supply in an MS140131GT-8

If the Micro Switch is installed with a downlink, this also requires one free M4 modular slot in the GT chassis.









Micro Switch installed with a downlink in an MS140131GT-8

! Configuration Example: GT Chassis **MICROSENS**



Description	Art. No.	Quantity
5-slot GT chassis, incl. 2x M45 dummy modules	MS140131GT-5	1
6-port GbE Micro Switch SNMP 1x100/1000-X (SFP slot), 5x10/100/1000-T	MS440209M-G6+GT	1
SFP GbE multimode	MS100200DX	1
M45 cold device socket GT	MS140150-GT	1
M45 dummy module GT	MS140033-GT	1
M45 cable cap GT	MS140160-GT	1
Desk adaptor	MS140144	1

6.2.1 Side Covers for MS140131GT

Image	Description	Article No.
	Opening for miniature cable duct 20 x 20 mm, GT	MS140162-GT
	M45 cold device socket GT (C14)	MS140150-GT
	M45 dummy module GT (RAL 7021)	MS140033-GT
	M45 module with cable conduits 2 x Ø13 mm + 4 x Ø6 mm, GT	MS140161-GT
	M45 cable cap GT	MS140160-GT
	M45 module with integrated cold device socket and fiber optic connection coupler LC simplex, GT	MS140159-GT-LCSSM
	M45 module with integrated cold device socket and fiber optic connection coupler SC duplex, GT	MS140151-GT-SCDMM

6.2 Slim Chassis

The compact MICROSENS Slim Chassis model is another chassis solution with numerous configuration options, comparable with those of the GT chassis. The design of the Slim Chassis has been optimised for light-coloured surroundings and is deployed primarily in health care and office environments. The front panel can be fitted with a range of different M45 components. The length can be configured in 45 module steps.

Matching accessories, such as supporting adapters, passive module components and cable feeds, can be found on pages 48 f. Upon request, individual, ready-to-use customer-specific configurations can be built and supplied by MICROSENS. You can also contact MICROSENS directly for support in configuring the exact solution you are looking for.



Image	Description	Art. No.
MS140131SL-x	4-slot M45 Slim Chassis, incl. 2x M45 dummy modules	MS140131SL-4
	5-slot M45 Slim Chassis, incl. 2x M45 dummy modules	MS140131SL-5
	6-slot M45 Slim Chassis, incl. 2x M45 dummy modules	MS140131SL-6
	7-slot M45 Slim Chassis, incl. 2x M45 dummy modules	MS140131SL-7
	8-slot M45 Slim Chassis, incl. 2x M45 dummy modules	MS140131SL-8
	9-slot M45 Slim Chassis, incl. 2x M45 dummy modules	MS140131SL-9
	10-slot M45 Slim Chassis, incl. 2x M45 dummy modules	MS140131SL-10
	11-slot M45 Slim Chassis, incl. 2x M45 dummy modules	MS140131SL-11

*For accessories, please refer to pages 48 f.





Configuration Example: SLIM Chassis

MICROSENS











Description	Art. No.	Quantity
4-slot M45 Slim Chassis, incl. 2x M45 dummy modules	MS140131SL-4	1
6-port GbE Medical Micro Switch SNMP 1x10/100/1000-T PD, 5x10/100/1000-T	MS445186PM-48G6+	1
Slim side cover, closed	MS140166SL	1
Slim side cover with RJ-45 connection	MS140164SL	1
N-rail 10x25, standard medical rail adapter (10x25)	MS140809	1

6.2.1 Side Covers for MS140131SL





Image	Description	Article No.
	Slim side cover, closed	MS140166SL
	Slim side cover with fiber optic connection, SC duplex	MS140167SL
	Slim side cover with RJ-45 connection	MS140164SL
	Slim side cover with cold device socket and fiber optic connection, SC duplex	MS140151SL-SCDMM
	Slim side cover with cold device socket and RJ-45 connection	n.n.
	Slim side cover with cold device socket	MS140150SL

6.3 Accessories



6.3.1 Installation Options for GT and SLIM Chassis

Image	Description	Article No.
	Under table installation set	MS140142
	Raised floor set, bracket for 2 chassis	MS140143
	Desk adaptor	MS140144
	Set with DIN rail brackets	MS140145-V2
	Holding magnet, 1x (at least 2 are needed)	MS140146
	Set of attachment tabs	MS140148
	N-rail 10x25, standard medical rail adapter (10x25)	MS140809
	N-rail 8x35, standard medical rail adapter "Carbamed" (8x35)	MS140809-CM

6.3.2 M45 Dummy Modules

Image	Description	Article No.
	M45 dummy module PW (RAL 9010)	MS140033
	M45 dummy module GT (RAL 7021)	MS140033-GT
	M45 dummy module, aluminium-coloured	MS140033-AL
	Half-size M45 dummy module PW	MS140034
	Half-size M45 dummy module GT	MS140034-GT

6.3.3 M45 Plug Sockets

Image	Description	Article No.
	Schuko socket 45°, GT (RAL 7021)	MS140174-GT
	Schuko socket 45°, PW (RAL 9010)	MS140174
	Schuko socket 45°, varnished aluminium	MS140174-AL

6.3.4 More M45 Installation Components

Image	Description	Article No.
	M45 cold device socket GT (C14) RAL7021	MS140150-GT
	M45 cold device socket GT (C13) RAL7021	MS140151-GT
	Half-size M45 Wieland connector, male RAL7021	MS140153-GT
	Half-size M45 Wieland connector, female RAL7021	MS140154-GT
	Half-size M45 Wieland snap-in connector RAL7021	MS140155-GT
	M45 Wieland snap-in connector RAL7021	MS140156-GT
	M45 Wieland snap-in for two connections RAL7021	MS140157-GT
	GEIM SCCR002/14 Wieland connector, male	
	GEIM SCCR001/14 Wieland connector, female	
	Device power cable GST18-3S, female, Schuko plug, 3x 2.5mm ² black	MS190105

6.4 Rapid 45 Installation Set for Surface Mounting

The perfect set for easily installing a MICROSENS Micro Switch. This model, which is simple in design and very easy to install, offers sufficient storage space to be able to perfectly hide all the required cabling.



Image	Description	Art. No.
	Set consisting of an M45 installation duct with upper and end sections for closure, dimensions 53x100x250 mm, pure white RAL 9010	MS140090
	Set consisting of an M45 installation duct with upper and end sections for closure, dimensions 53x100x330 mm, pure white RAL 9010 Special model for POE(+) (more space for the required power supply)	MS140090-330
	Set consisting of an M45 installation duct with upper and end sections for closure, dimensions 53x100x330 mm, pure white RAL 9010 Specially-designed 2-device model for PoE(+), incl., for example, a fed Micro Access Point	MS140090-500

*Longer version also available upon request



Micro Switch installed in an MS140090

7 Wall Installation

It is important to distinguish between the following types of wall installation:

- **Hollow wall installation:** For a hollow wall installation, the socket is inserted into an opening which has been specially drilled to size. The device bracket, switch and cover frame are then mounted accordingly.

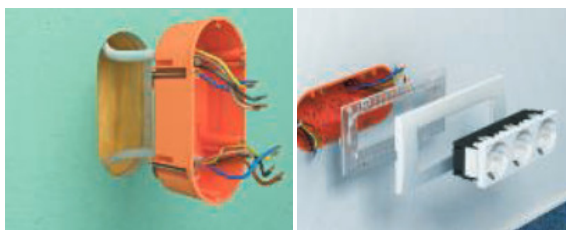

- **Concealed installation:** This option involves plastering the socket into the wall whilst using a cover to protect the inside of the socket from dirt. The device bracket, switch and cover frame are then mounted accordingly.



- **Surface mounting:** Surface mounting includes all installations carried out on top of the actual wall surface. The big advantage of this type of installation is the low expenditure required.



7.1 Installation Set for Hollow Wall Installation

This four-component hollow wall installation set was specially developed for compatibility with M45 modular technology and offers plenty of space for MICROSENS installation components. The set was designed using a triple M45 frame, allowing for easy access when connecting up power and fiber optic cables. The set also includes one M45 dummy module.

An optional locking bar can also be used to secure the Micro Switch.

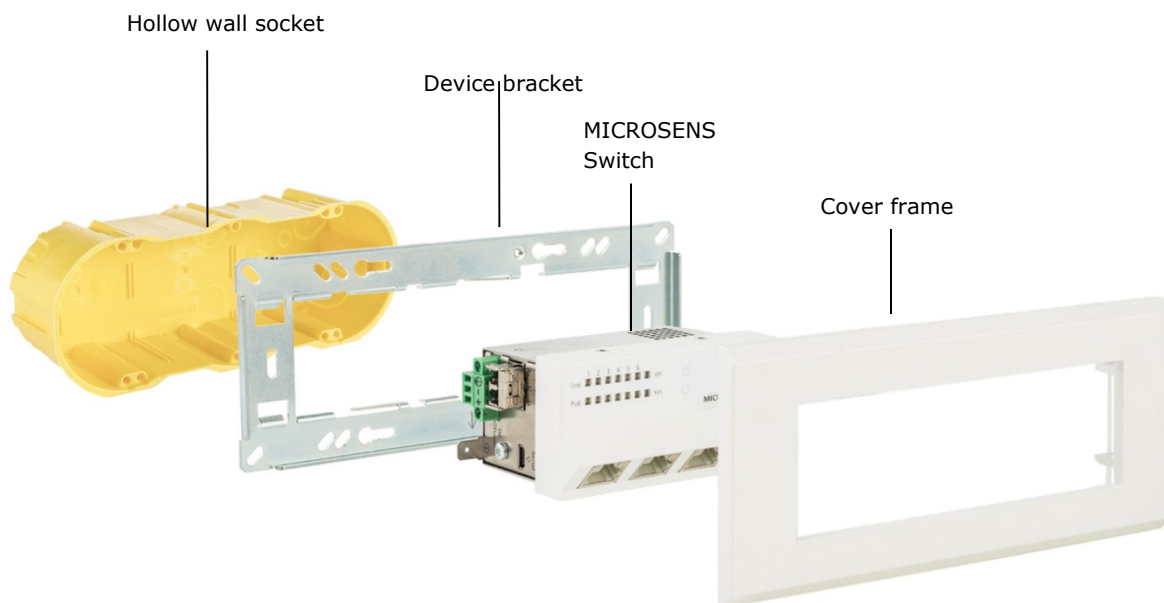



Image	Description	Art. No.
	Triple hollow wall socket, support plate, cover frame and M45 dummy module PW Socket dimensions: 183 x 69 x 50	MS140040HW3
	Locking device for MICROSENS 2-socket + 3-socket adapters, consisting of one locking plate and incl. 2 screws	MS140099

*Further colours upon request





Micro Switch + MS140040HW3

7.2 Installation Set for Concealed Wall Installation

This four-component concealed wall installation set was specially developed for compatibility with M45 modular technology and offers plenty of space for MICROSENS installation components. This set was designed using a triple M45 frame, allowing for easy access when connecting up power and fiber optic cables. The set also includes one M45 dummy module.

An optional locking bar can also be used to secure the Micro Switch.



Image	Description	Art. No.
	Triple concealed wall socket, support plate, cover frame and M45 dummy module PW Socket dimensions: 186 x 90 x 50	MS140040UP3
	Locking device for MICROSENS 2-socket + 3-socket adapters, consisting of one locking plate and incl. 2 screws	MS140099

*Further colours upon request



Micro Switch with cover installed in a concealed wall socket

7.3 Installation Set for KAISER Sockets

This two-component set contains an adapter plate with an M45 track which can be used to insert a Micro Switch and corresponding cover frame without the need for further tools. The adapter plate was specially developed for KAISER sockets. An overview of matching sockets is available on the next page.

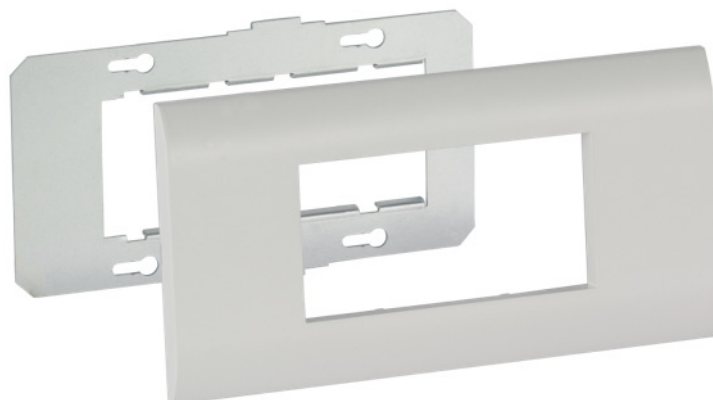



Image	Description	Art. No.
	Installation set for KAISER sockets consisting of an adapter plate and matching double cover frame	MS140045

*Further colours upon request







Micro Switch with cover installed in a hollow wall socket

7.3.1 Alternative Hollow Wall, Concealed and Surface-Mounted Sockets

F-tronic

Image	Type/Article No. Dimensions L x W x D (mm)	Description	Suitable MICROSENS Installation Set
	E118 143 x 67 x 47	<ul style="list-style-type: none"> Suitable for hollow wall and concealed installation When installing, make sure to use a core cutter with edge countersink Burr hole Ø 2x 68 mm 	MS140045

KAISER

Image	Type/Article No. Dimensions L x W x D (mm)	Description	Suitable MICROSENS Installation Set
	9062-94 143 x 67 x 75	<ul style="list-style-type: none"> Electronic Socket for: Hollow walls and concealed installation (deep version, air-tight) Colour: Orange Burr hole Ø 2x 68 mm 	MS140045
	9062-74 143 x 67 x 75	<ul style="list-style-type: none"> Electronic Socket for: Hollow walls and concealed installation (deep version, air-tight) Colour: White Burr hole Ø 2x 68 mm 	MS140045
	9062-02 143 x 67 x 47	<ul style="list-style-type: none"> Electronic Socket for: Hollow walls and concealed installation Colour: Orange Burr hole Ø 2x 68 mm 	MS140045
	9062-77 143 x 67 x 47	<ul style="list-style-type: none"> Electronic Socket for: Hollow walls and concealed installation Colour: White Burr hole Ø 2x 68 mm 	MS140045

7.4 PoE+ Power Supply Installation in a Wall Configuration

The implementation of Power-over-Ethernet functionality requires a 48 VDC power supply (resp. up to 54 VDC in the case of PoE+) and an adequate power budget. As a rule, external power supplies, which can be integrated during installation, are used.

When implementing a PoE+ system in a wall configuration, there are various different options for installing the respective power supply models.

7.4.1 Installing a PoE+ Power Supply in a Wall Configuration

Due to its compact dimensions and specific properties, there is a variety of options for installing a flexible MS700710 power supply in a wall configuration.

On the one hand, such power supplies are typically integrated into a separate casing. These are then covered over by matching M45 dummy modules so that they are not visible from the outside.

Alternatively, another practical solution is to attach the power supply to the back of the casing of the installed Micro Switch - assuming that the environmental conditions are suitable and offer enough space (e.g. in a hollow wall situation). In this case, the bottom of the power supply is installed, resp. screwed/riveted into place using the integrated mechanism.



The back of an MS700710 rivetted onto an MS140040HW3

8 Furniture Installation

For users who do not have any device installation ducts or floor tanks or have no desire to install them subsequently, this category offers a wealth of solutions. Here you will find practical, easy-to-install options and attractive designs for numerous applications, including office desks, laboratories, cupboards and counter tops.



8.1 Furniture Inlet Casing

This installation set is easily built in by simply inserting it into a specially-made opening set into the surface of the respective item of furniture. This space-saving and stylish solution allows a Micro Switch to be accommodated close to the user. MICROSENS offers a choice of two models depending on the depth of the inlet: One with cable outlets at the rear and one with lateral cable outlets – both solutions provide plenty of space for accommodating the cabling. An optional fixing set is also available.

Examples of different installation options: Set into a desk, cupboard or counter top.

Please refer to page 48 for a list of components which can be integrated into these additional modules.



Image	Description	Art. No.
	5-slot M45 furniture inlet module, cover made of polished, chrome-plated steel, cable outlets at the rear, designed for desktop depths of between 10..24 mm	MS140128R-5
	5-slot M45 furniture inlet module, cover made of polished, chrome-plated steel, cable outlets at the sides, designed for desktop depths of between 10..24 mm	MS140128S-5

*For accessories, please refer to page 48 f.



Configuration Example: Furniture Inlet Casing

MICROSENS





Description	Art. No.	Quantity
5-slot M45 furniture inlet module, includes the casing and 2x M45 dummy modules	MS140128R-5	1
6-port GbE Micro Switch SNMP 1x10/100/1000-T PD, 5x10/100/1000-T	MS450186PM-48G6+GT	1
Schuko socket 45°, GT	MS140174-GT	2

8.2 Retractable Modular Aluminium Pillar

This installation set is an excellent solution for conference rooms as the whole unit, including all the active equipment, simply retracts into the table. Due to the 45 x 45 socket rail design, all MICROSENS installation components are perfectly housed in this chassis which also offers plenty of space for additional modular components, such as power outlets. The cover is available in either graphite grey or silver.

Please refer to page 48 for a list of installable components for these additional modules.



Image	Description	Art. No.
	For up to four M45 modules, set includes one chassis, 2x half-size M45 dummy modules and one M45 dummy module, colour: GT	MS140122-GT-4
	For up to five M45 modules, set includes one chassis, 2x half-size M45 dummy modules and one M45 dummy module, colour: GT	MS140122-GT-5
	For up to six M45 modules, set includes one chassis, 2x half-size M45 dummy modules and one M45 dummy module, colour: GT	MS140122-GT-6
	For up to seven M45 modules, set includes one chassis, 2x half-size M45 dummy modules and one M45 dummy module, colour: GT	MS140122-GT-7
	Cover GT	MS140124-GT
	Cover: Silver	MS140124-AL
	Cable inlet for MS140122 chassis	MS140124-CA
	Cable inlet for MS140122 chassis, incl. strain relief	MS140124-CASR

*For accessories, please refer to page 48.



Micro Switch installed in an MS140122-GT pillar



MS140122 pillar, retracted in a desktop surface

9 Industrial Installations

Industrial applications generally pose a special challenge when it comes to physically installing active components. MICROSENS offers a range of accessories which are ideally suited to these areas of application.

9.1 DIN Rail Installation

MICROSENS offers a special adapter which can be used to attach M45 installation components to a DIN rail (resp. inside a distribution panel). This is used to snap the installation components onto a 35 mm DIN rail. A respective installation set consists of one adapter plate and a plastic bracket designed for 35 mm DIN rails. This set can be used to optimally align the components at 90° angles.

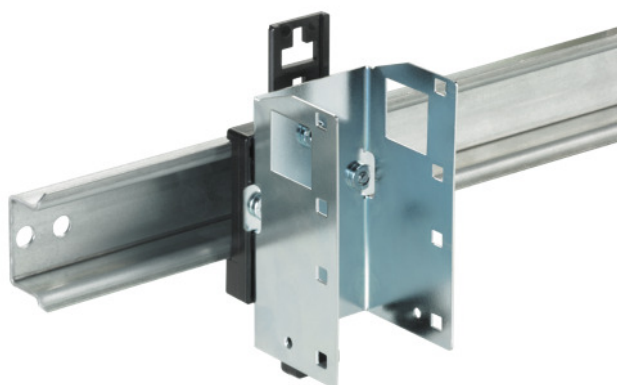

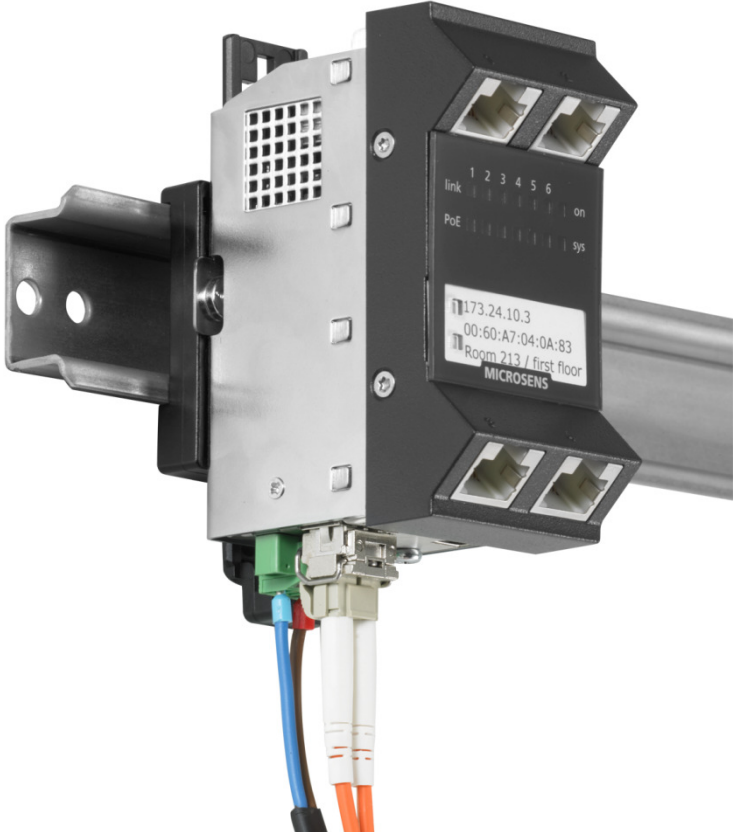

Image	Description	Art. No.
	DIN rail adapter for Micro Switch, for 35 mm DIN rails. The device is simply snapped into place *The G6 switch can be aligned either horizontally or vertically	MS140805-G6



Horizontal Micro Switch attached to a DIN rail using an MS140805-G6



Micro Switch – vertical model, attached to a DIN rail using a MS140805-G6*

*The Micro Switch is also available in a ruggedised version to accommodate a broader range of temperatures

9.2 IP67 Mast Box

With their IP67 Mast Box model, MICROSENS offers a pre-assembled, compact chassis which is ideal for integrating a ruggedised Gigabit Micro Switch. It allows WLAN access points, video cameras, weather stations, barrier systems as well as monitoring and surveillance systems to be connected up to an IP network in outdoor areas.

As a rule, the chassis is assembled using a clamp band or corresponding mounting bracket. The particularly compact chassis design also allows it to be installed right inside a mast. Optional mast hooks are available for this purpose. The pre-assembled IP67 chassis comes with a fiber tray which supports the accommodation of fiber optic connections. One has the choice of providing the required voltage through a 230 VAC or 24 VDC connection. A special model is available for PoE applications which comes with a pre-installed 48 VDC power supply, whereby the 230 VAC feed cable is connected via a terminal block. The chassis is equipped with three PG gland joints (2x PG11 and 1x PG16) for connecting the cables. There is also a pre-drilled slot which offers the option of creating a further PG13 gland joint.

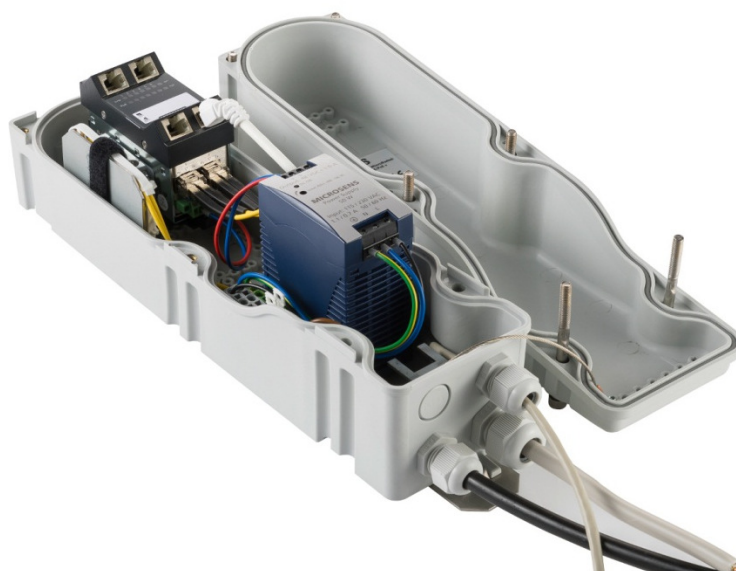





Image	Description	Art. No.
	IP67 Mast Box, incl. fiber cassette and DIN rail, 1x PG16 + 2x PG11 gland joints (it is also possible to create one additional PG13 outlet)	MS711000
	Pre-assembled IP67 Mast Box, prepared to take up a Micro Switch, with an internal 24 VDC power supply, incl. fiber cassette and DIN rail, 1x PG16 + 2x PG11 gland joints, Micro Switch not included	MS711000-24
	Pre-assembled IP67 Mast Box, prepared to take up a Micro Switch, with an internal 230 VAC power supply, incl. 230 VAC input, surge protection module, incl. fiber cassette and DIN rail, 1x PG16 + 2x PG11 gland joints, Micro Switch not included	MS711000-230
	Pre-assembled PoE+ IP67 Mast Box, prepared to take up a Micro Switch with PoE/PoE+ functionality, incl. a 48 VDC DIN power supply, incl. fiber cassette and DIN rail, 1x PG16 + 2x PG11 gland joints, Micro Switch not included	MS711000-230NT48
	Mast hooks for attachment to a mast	MS711000-PH

The 6-port Gigabit Ruggedised Micro Switch is ideally suited for deployment as an active network component and is available in a variety of models to meet different requirements. Three different voltages are catered for (48 VDC for PoE/PoE+ applications), 24 VDC and 230 VAC). The models also incorporate three different types of port (2x fiber optic for bus and ring topologies, 1x fiber optic as well as a pure RJ-45 model).

Simply combine the IP67 Mast Box with a ruggedised Micro Switch for a high-performance and compact active distributor for outdoor areas.



Configuration Example: PoE Mast Box

MICROSENS



Description	Art. No.	Quantity
Pre-assembled PoE+ IP67 Mast Box, prepared to take up a Micro Switch with PoE/PoE+ functionality, incl. a 48 VDC DIN power supply, incl. fiber cassette and DIN rail, 1x PG16 + 2x PG11 gland joints	MS711000-230NT48	1
6-port GbE Ruggedised Micro Switch PoE+ 1x10/100/1000-X (SFP slot), 5x10/100/1000-T	MS440219PMXH-48G6+	1
SFP GbE single mode	MS100210DX	1

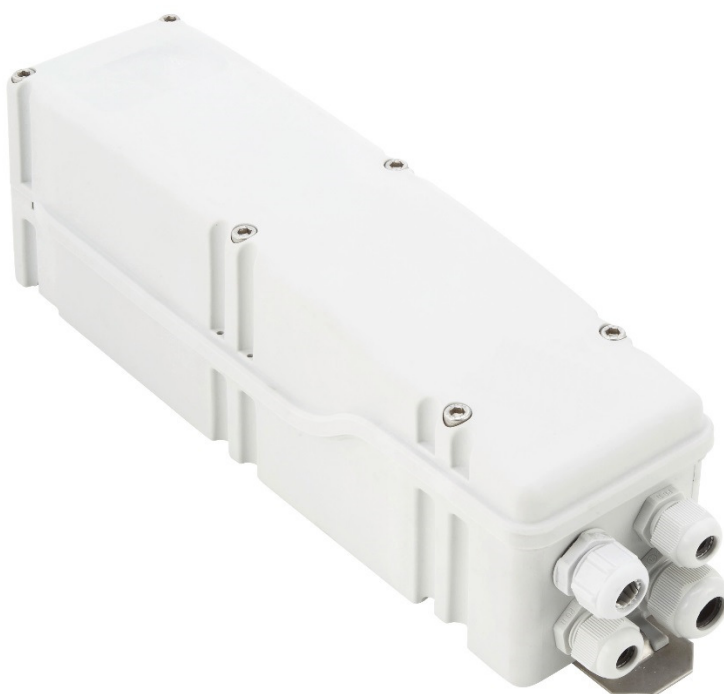

IP67 Mast Box, closed, including an additional PG13 gland joint

9.3 19" Profile with 35 mm DIN Rail

Robust solutions for environments using industrial technology, such as switches, converters and power supplies, are usually mounted on 35 mm DIN rails. As a result, these components are equipped with matching brackets which can be simply snapped onto the rails. In numerous applications, these reliable systems need to be installed in 19" cabinets.

MICROSENS offers an appropriate 19" aluminium profile with an integrated 35mm DIN rail specifically for this purpose. This makes it really easy to install industrial components straight into a 19" cabinet - without the need for temporary solutions. This solid profile is 4U high. As its DIN rail is set back, the unit offers plenty of space to accommodate all the technology required to connect up the devices at the front.



Image	Description	Art. No.
	19" aluminium profile with an integrated 35 mm DIN rail, specially designed for installing industrial components in 19" cabinets, height: 4U	MS140819



MS140819 with installed MICROSENS components

9.4 Additional Accessories for the Industrial Sector

Industrial solutions are generally mounted on DIN rails. MICROSENS offers a range of convenient accessories to guarantee that these solutions are appropriately installed. Combining a product with a matching power supply is one of the most frequent requirements for which MICROSENS offers a range of suitable cable kits in a variety of different lengths.

For cable routing applications, MICROSENS offers reliable strain relief products in two different qualities which can be simply snapped onto a DIN rail. Should the level of tensile force be higher, metallic cable fixing plates are also available. The industrial solutions portfolio is complemented by a range of additional installation accessories, such as end clamps and brackets designed to incorporate M45 modular technology.

Do you need any other accessories? Then please feel free to contact us!

9.4.1 Device Wiring

Image	Description	Art. No.
	Equipment supply cable, end sleeves 2x 1.5mm ² 10 cm long, red/black litz wires, ends open	MS190120-0.1
	Equipment supply cable, end sleeves 2x 1.5mm ² 20 cm long, red/black litz wires, ends open	MS190120-0.2
	Equipment supply cable, end sleeves 2x 1.5mm ² 50 cm long, red/black litz wires, ends open	MS190120-0.5

9.4.2 Cable Feed, resp. Cable Fixing Plate

Image	Description	Art. No.
	Single strain relief for DIN rail, black plastic	MS140820-1
	Four-fold strain relief for DIN rail, black plastic	MS140820-4
	Double strain relief for DIN rail, metallic	MS140821-2
	Four-fold strain relief for DIN rail, metallic	MS140821-4

9.4.3 Locking Block for DIN Rails

Image	Description	Art. No.
	Single strain relief for DIN rail, black plastic	MS140820-1
	Four-fold strain relief for DIN rail, black plastic	MS140820-4
	Double strain relief for DIN rail, metallic	MS140821-2
	Four-fold strain relief for DIN rail, metallic	MS140821-4



MICROSENS GmbH & Co. KG

Küferstr. 16

59067 Hamm/Germany

Tel.: +49 2381 9452-0

Fax: +49 2381 9452-100

Email: sales@microsens.com

Web: www.microsens.com